

Step 15

Now between two people turn over the Affinity Pool and insert the Liner Bag (Part 5). Place the liner bag inside the Affinity pool and carefully unpack it to fit the inside. You will see that a hook is present on the trident sections (parts 15, 16 & 17). This enables you to hook each eyelet of the liner to the hook on the trident connector. Ensure the liner is positioned with the windows correctly lined up with the windows on the Mocha Window panels, see exploded diagram for reference.

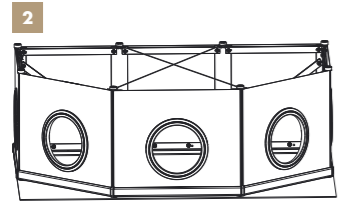

To be able to hook the liner easily, place the eyelet perpendicular to the top of the hook and slide to the back of the hook before allowing the eyelet to drop down into the groove behind and become secure. Do this to all 8 of the eyelets around the pond.

Once the eyelets have been hooked to the trident connectors, you will see there are 2 more eyelets present on the liner bag positioned evenly on each panel. Using 14 planting basket fixing pins, connect these eyelets to the flat edge of the top rails, see image 2 below, leaving the middle back panel loose for the moment.

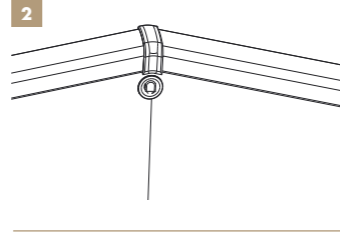
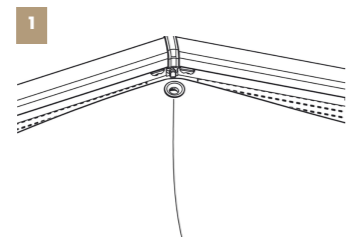
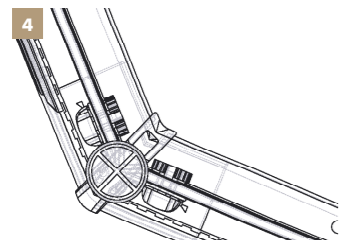
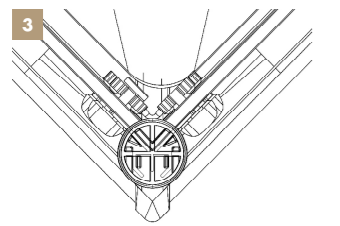

Step 16

Place the Inpond 5 in 1 filter inside the pond and thread the cable between the liner bag (part 5) and the frame of the pool. Use the section of liner that you left unattached in step 15, this will help to keep the cable tidy and out of harms way. Once the cable has been threaded through the gap, attach the eyelets on the liner bag to the holes on the top rail using 2 of the Plant basket fixing pins (part 3). See Inpond instructions on how to set up the filter correctly. Do not turn the Inpond on at this time.

Step 17

Two planting baskets (part 10) and six planting basket fixing pins (part 3) are supplied which allows you to have a plant basket on any panel of the Affinity Pool. Each top rail has three holes on the underside that allow the planting basket to be pinned in with the fixing pins, see image 1 for reference. The grip of the pins can be adjusted using the inside screw.

Additional baskets are available to purchase separately. Use pond plant compost to plant your chosen aquatic plants.

Tip: To help hide the filter cable, you can use the planting basket on the panel that you have threaded the cable through.



affinity®
living feature pools

grand half-moon

mocha weave & black aluminium
instructions



HOW TO
BUILD YOUR
AFFINITY VIEW
SEE WEBSITE

www.affinitypools.co.uk
www.pondaquariumproblemsolver.co.uk/blagdon

To keep your Affinity Pool windows clean, use **ONLY** the Affinity anti-scratch window cleaning pads code 1051200. Any other material may scratch or damage the windows. Polymer wool pads supplied are for the Inpond 5 in 1 filter, (see instruction manual).

All these items are available as replacements from your retailer.

For further information, see our website: www.affinitypools.co.uk

Guarantee

This product is guaranteed against defects in material and workmanship for 3 years from the date of purchase, under normal usage. The guarantee DOES NOT APPLY in case of improper use, negligence, lack of maintenance or accidental damage to the Affinity Pool. If the Affinity Pool fails due to a manufacturing fault within this period it will be either repaired or replaced free of charge. Liability is limited to replacement of the faulty product only; no other costs will be reimbursed.

This guarantee is not transferable and does not affect your statutory rights. This guarantee does not confer any rights other than those expressly set out above. Excludes consumable parts (pump Impellor, LED light & UVC lamp). If any parts are needed, spares are available from your retailer. Please see the Inpond 5 in 1 3000 instructions for more information and part descriptions.

Environment Friendly Disposal

You can help protect the environment! Please remember to respect the local regulations and hand in any non-working electrical equipment to an appropriate waste disposal centre.

Consumer Advice Contact Information

Interpet (Blagdon) Consumer Advice Department,
Vincent Lane, Dorking, Surrey RH4 3YX
E-mail: customercare@interpet.co.uk
www.affinitypools.co.uk

IMPORTANT: PLEASE ATTACH PROOF OF PURCHASE TO THIS MANUAL AND FILE IN A SAFE PLACE.



Affinity feature pools have been designed by a leading British water gardening company. Over half a century of fish keeping and water gardening knowledge is brought together in this product, so you can be assured of a successful, creative water feature.



Grand Half-Moon Assembly Instructions

Getting to know your Affinity living feature pool

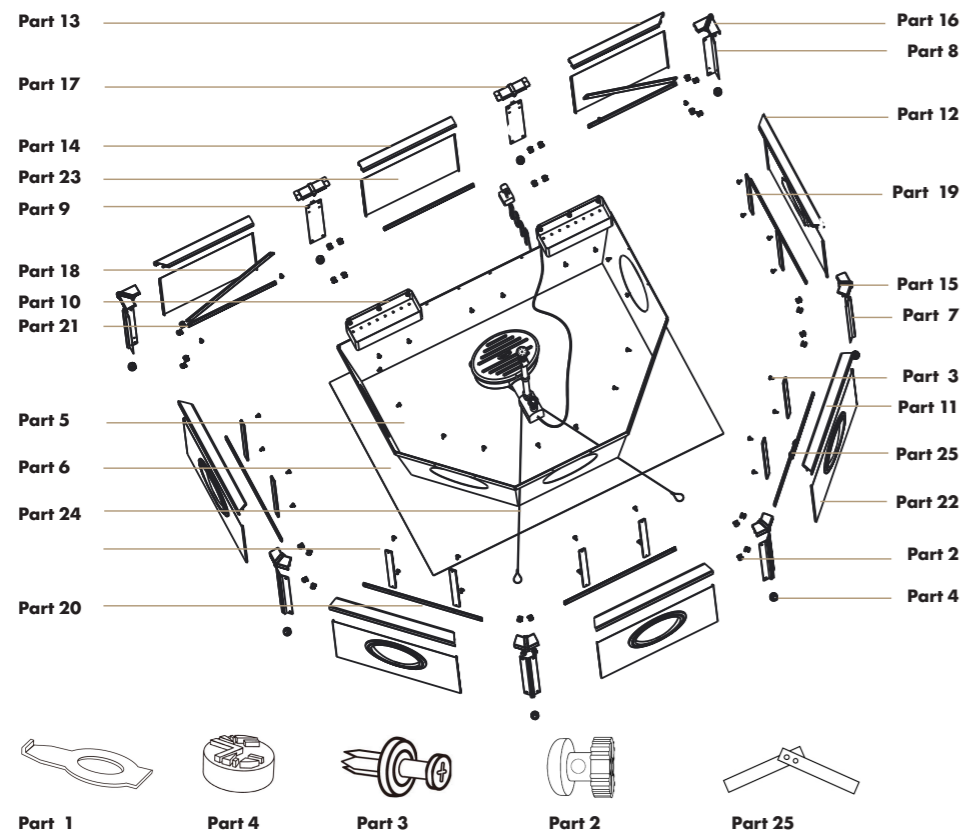

Part List

Part Description	Quantity	Part No.
Tool	1	1
Plastic Key	32	2
Planting Basket Fixing Pin	46	3
Leg Feet	8	4
Grand Half-moon Liner	1	5
Underlay	1	6
135 Degree Leg	4	7
90 Degree Leg	2	8
180 Degree Leg	2	9
Planting Basket	2	10
Front Top Rail (A)	3	11
Side Top Rail (B)	2	12
Back Side Top Rail (C)	2	13
Back Middle Top Rail (D)	1	14
135 Degree Trident Connector	4	15
90 Degree Trident Connector	2	16
180 Trident Connector	2	17
Diagonal Bracing Bar	2	18
Vertical Bracing Bar	10	19
Window Leg Cross Bracing Bar	4	20
Back Leg Cross Bracing Bar	3	21
Mocha Weave Window Panel (A)	5	22
Mocha Weave Non-Window Panel (B)	3	23
Strengthening Wire	2	24
Tension Bar	1	25

Technical specifications
52cm (H) x 147cm (W) x 104cm (D)
480 litres (105 gallons)

Also Available

Part Description	Product Code
Blagdon Inpond 5 in 1 3000 Maintenance Kit	1054928
Blagdon Grand Affinity Planting Basket	1055857

Step by Step Guide

Step 1

Please remove all of the relevant parts from the packaging and double check that all of the items are enclosed, use the complete parts list and the exploded diagram to check this.

1 Line up and push fit together

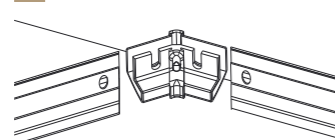

Step 2

Identify a suitable area where your Affinity Pool can be placed, ensure that the area is level with a firm base and is free from stones or any other debris that could damage your liner bag.

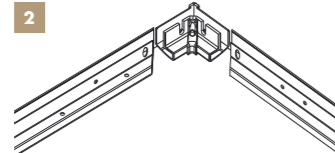

Step 3

Using your supplied underlay (part 6) lay it flat over the cleaned area ensuring it covers the entire area where the liner will sit. Underlay is very important as it protects your liner bag from puncture or damage and prevents any possible unwanted leaks.

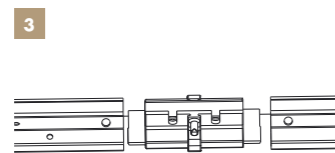

Step 4

Now using all of the top rails (parts 11, 12, 13 & 14) and all of the trident connectors (parts 15, 16 & 17) connect them together in a half-moon shape. The trident connectors, images 1, 2 & 3, allow the top rails to slot into each other, ensure the bottom oval holes are completely free of obstruction.

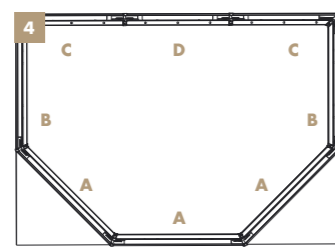

The top rails are labelled A, B, C & D as per image 4, to aid you in correct construction, and should fit together with the trident connectors as per image 5. (please note only 135 degree connection shown)

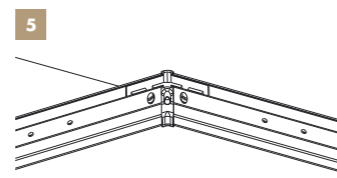

Step 5

Using the legs (parts 7, 8 & 9) insert them into the trident connectors as per images 1 and 2. Ensure the end of the leg with the white sticker is not inserted first but are located at the top of the leg once inserted and lined up with the oval holes. The two 90 degree legs fit the 90 degree trident connectors, the 135 degree legs for the 135 degree trident connectors and the two 180 degree legs for the 180 degree trident connector, see the image on step 6 for reference.

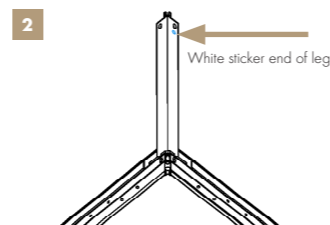
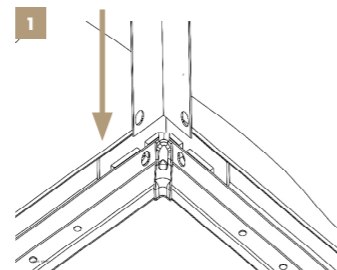

Step 6

Your Affinity Pool should now have all 8 of the legs inserted the right way up and be ready to have the plastic keys (part 2) inserted at the bottom of the top rails. It should look like the image below with all 8 legs inserted.

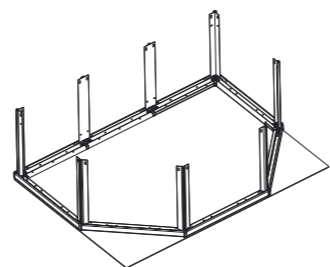

Step 7

This step requires you to use 16 of the plastic keys (part 2), insert them into each of the oval holes at the base of all the tridents on both sides, 2 per trident. Image 1 shows the first keys being inserted into the oval holes. The oval holes must not be covered but be completely free and open to ensure the keys can fit in easily. Continue to insert all 16 keys.

Now using the supplied tool (part 1) turn the keys a quarter turn so they lay flat and lock into position as per image 3. Continue to do this to all 12 keys around the base of the pond until all 6 legs are firmly connected to all 6 trident connectors.

Note: the tool has 2 ends to allow for each degree connector.

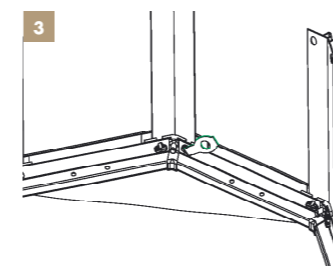
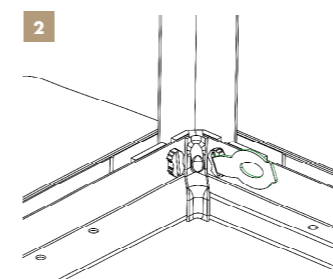
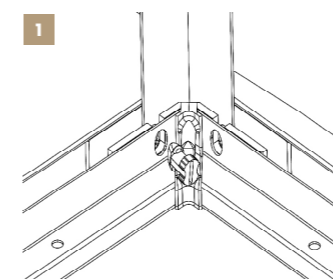

Step 8

Now would be a good time to look at the exploded diagram and take note of the position of each of the windows on the liner bag (part 5). The 5 windows are positioned at the front, and to the sides of the half-moon. You must make sure the window panels (part 22) are positioned in these slots as per the exploded diagram.

The panels are divided between A & B, which will help guide you on which panel needs to go where.

Identify the window panels first, labelled A (part 22) and slot them into the correct legs, see exploded diagram. You will have to use two hands and slot both sides of the panel at the same time to ensure it fits easily and correctly between the legs to the bottom rail. Ensure the window frames are facing outwards and are slotted into the legs the right way.

Labels on the panels which have "to the inside" on them means that the side of the panel needs to face towards the inside of the pond.

Once the window panels have been inserted, insert the non-window panels (part 23) into the 3 remaining slots across the back of the pool.

Tip: When sliding the panels into the curved slot sections on the legs ensure the panels are wet with water. This will aid the slotting process of all the panels into the legs.

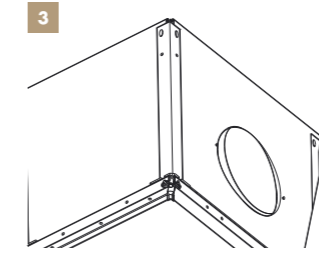
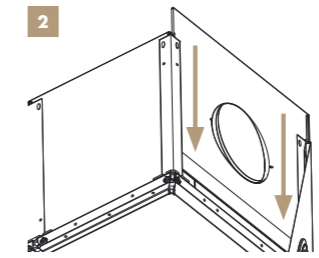
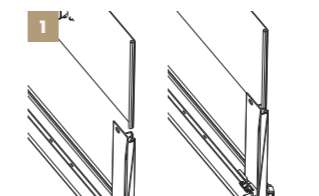

Step 9

Once all of the panels have been inserted your pool should look like the image below

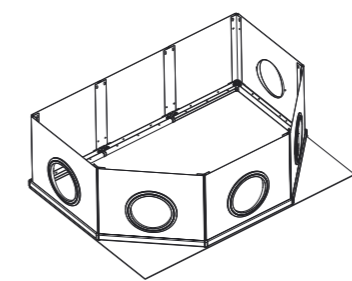

Step 10

Now using the leg cross brace bars (parts 20 & 21) and 14 of the remaining plastic keys (part 2) insert them one at a time, working your way around the pond leaving one window panel empty. Lock the plastic keys by quarter turning them, using the provided tool (part 1).

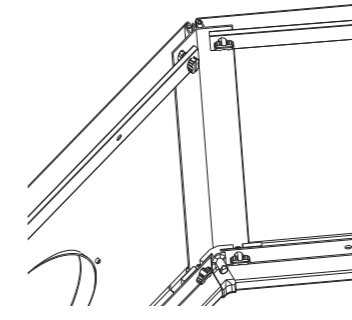

Step 11

Once the 7 leg cross bracing bars are in position, it is time to insert the tension bar (part 25). Adjust the angle of the bar to match the remaining gap in the frame and insert the remaining two plastic keys (part 2) as per image 1 below. Once the keys are in position lock them with a quarter turn using the provided tool (part 1), then apply pressure to the tension bar to make it straight as per image 2 below. With the bar straight, insert a plant basket fixing pin (part 3) into the remaining empty hole to lock the bar into position as per image 3 below.

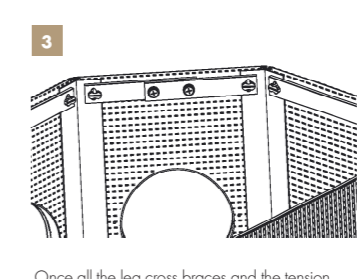
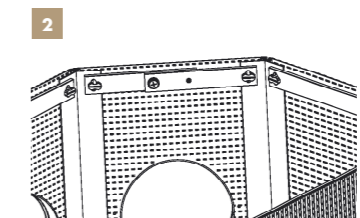
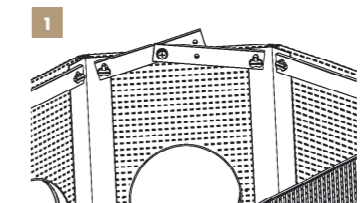

Once all the leg cross braces and the tension bar have been inserted, and the keys locked the panels of your Affinity Pool should be pulled tight as per image 4 below.

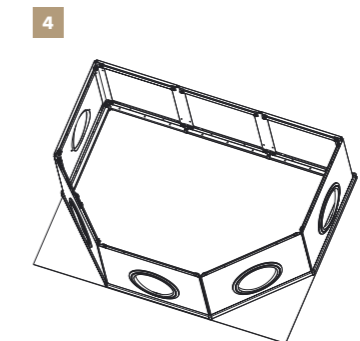

Step 12

Now using the 10 vertical bracing bars (part 19) and 20 of the plant basket fixing pins (part 3) attach them to the holes provided in the top rail and leg cross brace bars on the window panels. Ensuring the vertical bracing bar is attached to the top rail and the leg cross brace bar on the side that will be closest to the liner.

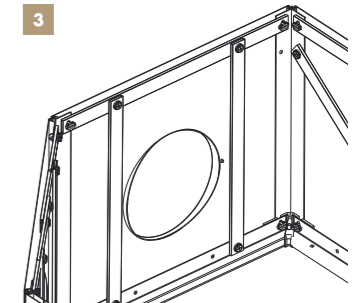
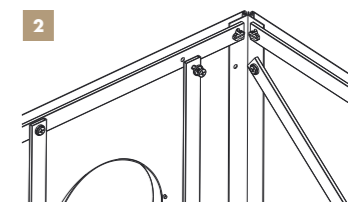
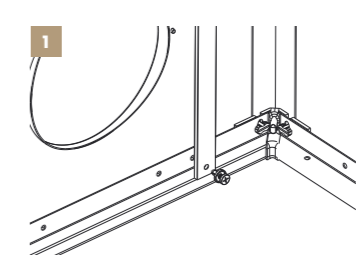

Step 13

Now using the 2 diagonal bracing bars (part 18) and 4 plant basket fixing pins, attach one end to one of the holes present on the 90 degree leg and attach the other diagonally across to the closest 180 degree leg as per image 1. Once attached the bars should look like image 2.

Note: there are holes at the top and bottom of each of these legs, either can be used for this step.

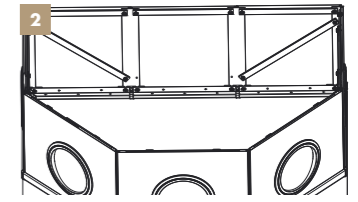
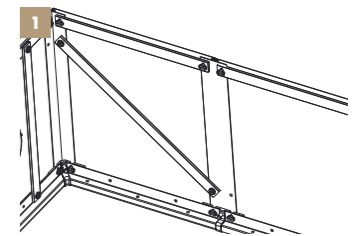

Step 14

Check all parts are secure and correct then, using the 2 strengthening wires supplied (part 24) attach one loop from each to the front 2 135 degree legs, using the supplied feet (part 4) to hold them in place, these clip into place easily and ensure the pond is level and secure, see image 1 for reference. Now draw the wires diagonally across the pond to the opposite 180 degree legs, forming a cross where the wires meet, again use a one of the supplied feet to hold the wires in place on the 180 degree legs, see image 2 for reference. Continue to attach the remaining 4 feet to the remaining empty legs. Any of the feet can fit any of the 90, 135 or 180 degree legs, see images 3 and 4 for reference.

Important: Before moving on to step 15, ensure all the labels are removed from the panels, as you will be unable to remove them once the liner bag has been inserted.

Continued on back page.