

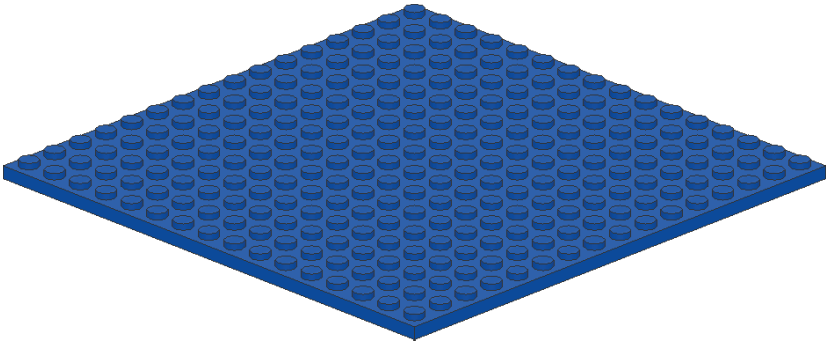

1

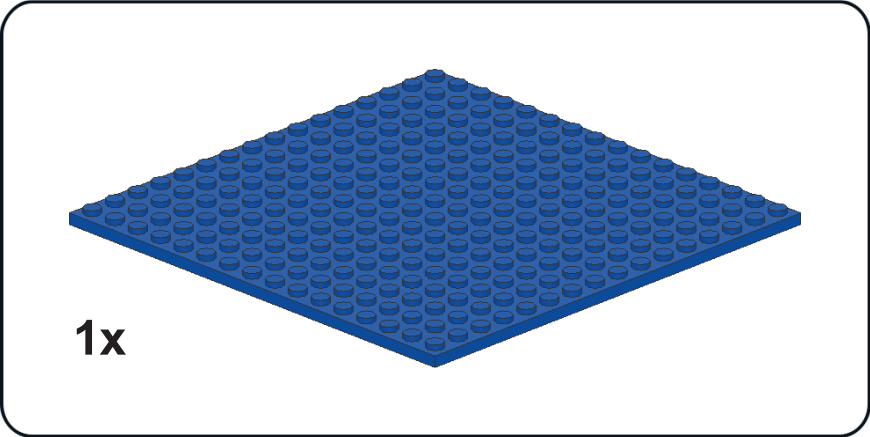

2

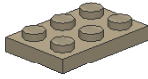

3x

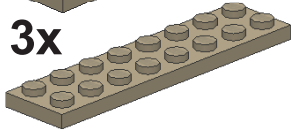

1x

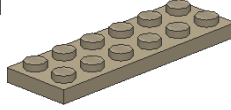

1x

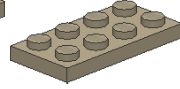

2x

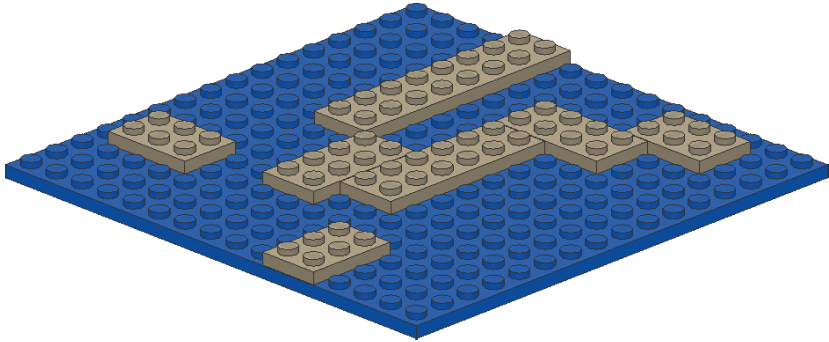

3



8x



2x



1x

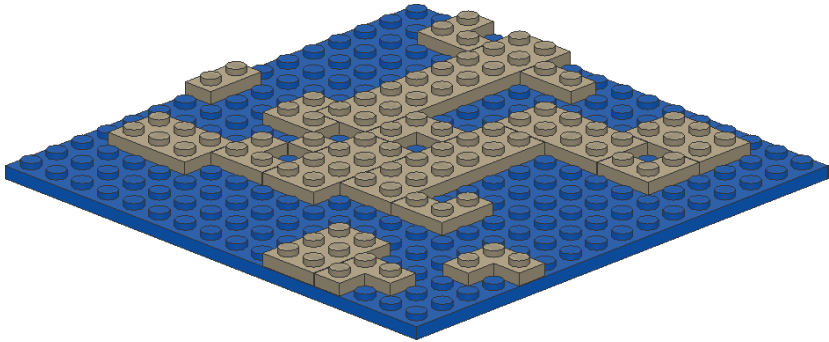

4

2x 4x 1x 2x 2x

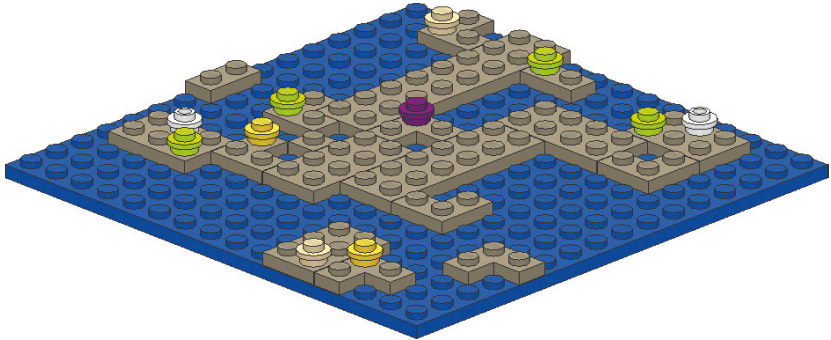

5

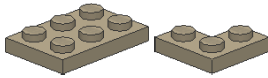

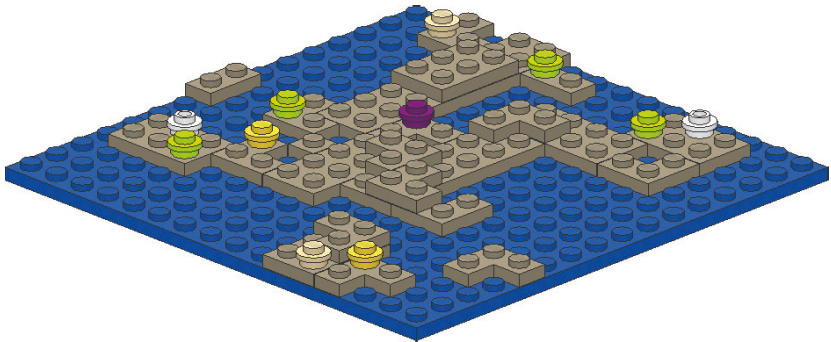
1x 4x

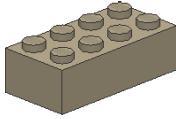

6

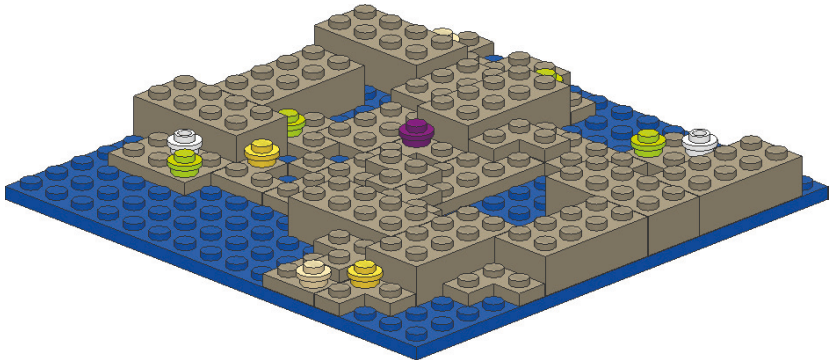

9x



7

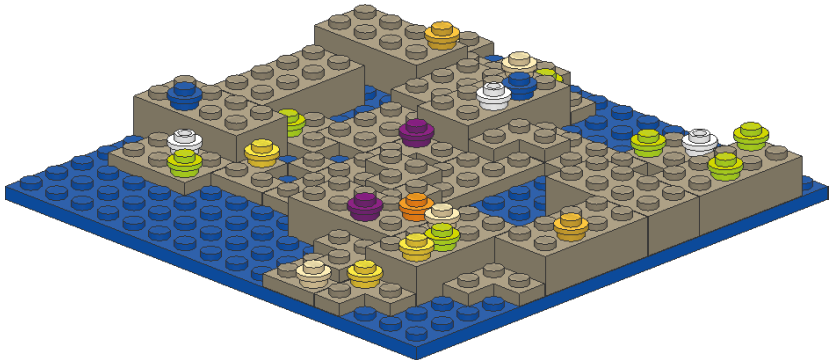

8

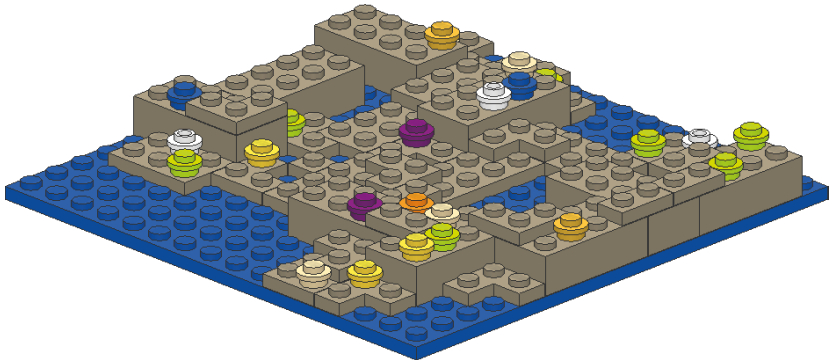
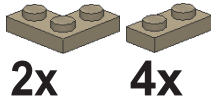

9

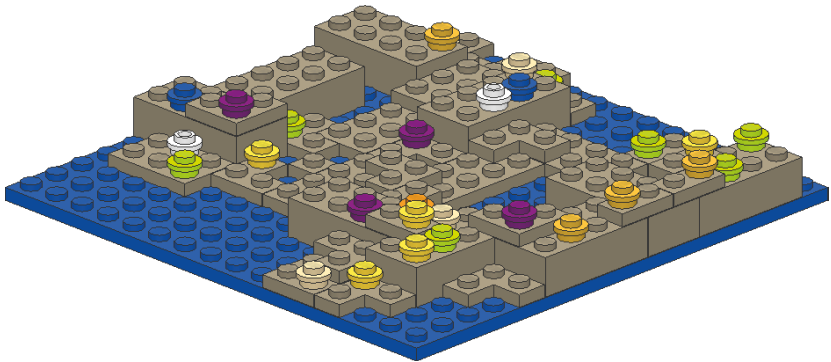

10

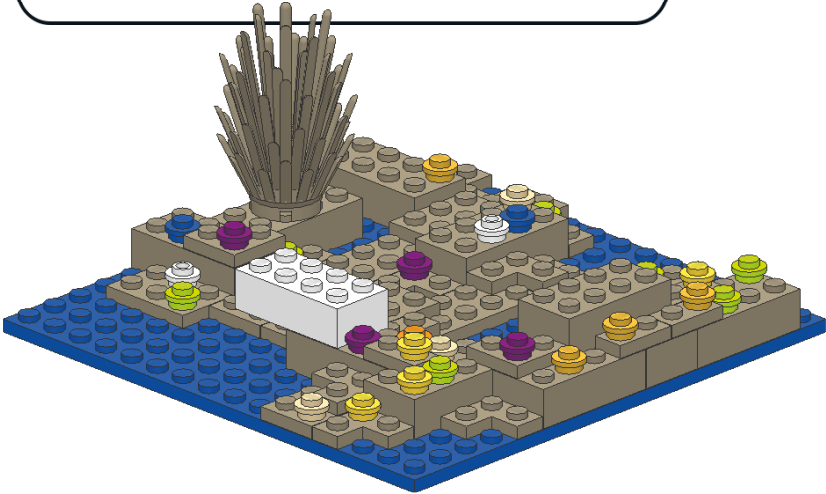
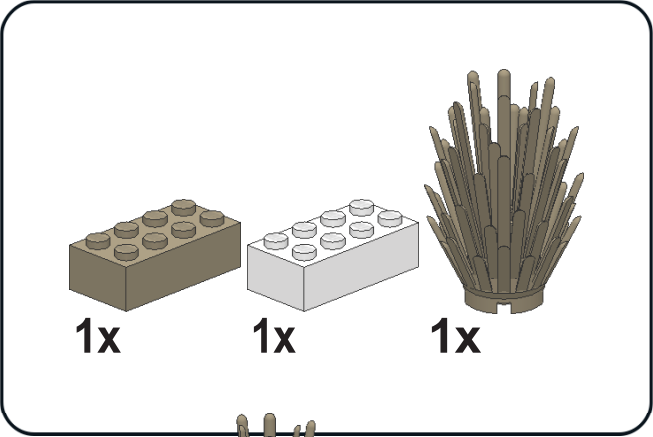

11

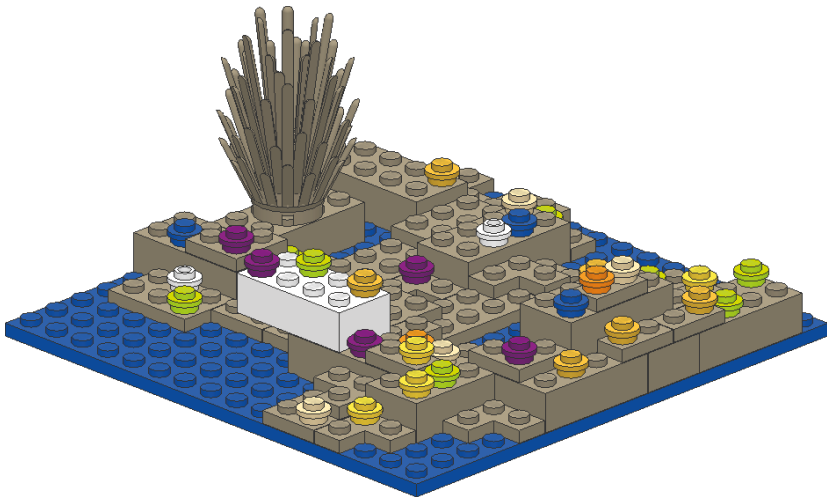
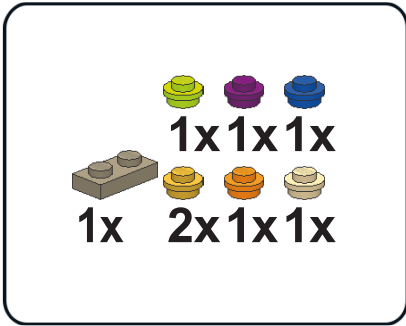

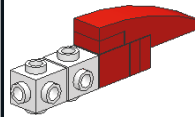
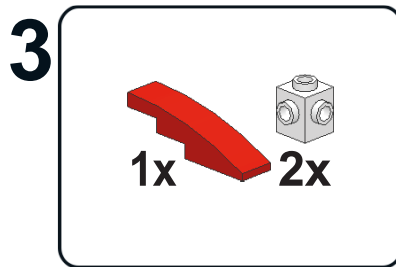
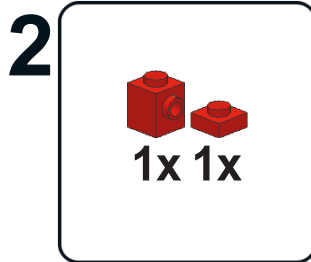
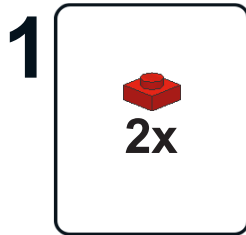

4

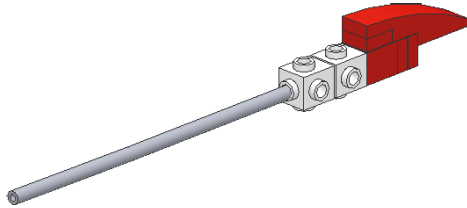

5

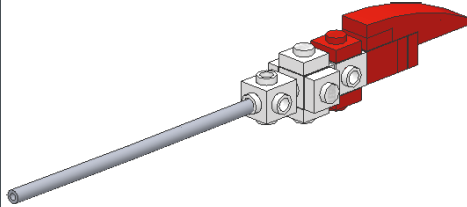
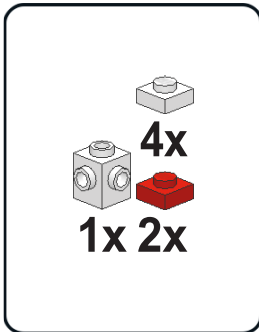

6

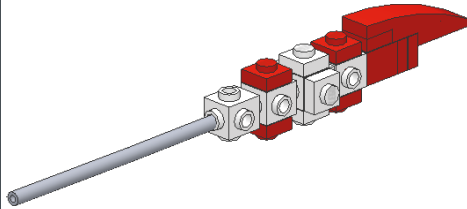
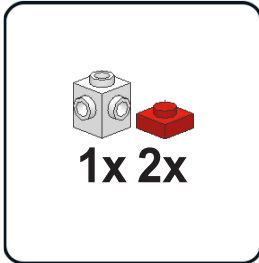

7

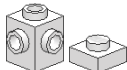
1x 4x

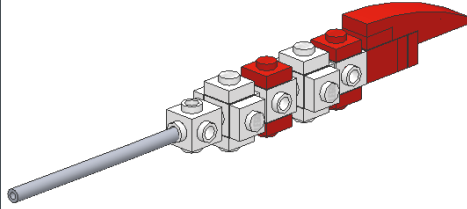

8

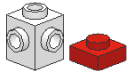
1x 2x

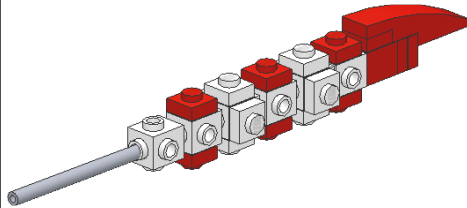

9

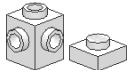

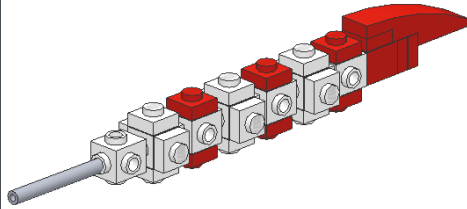
1x 4x

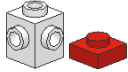

10

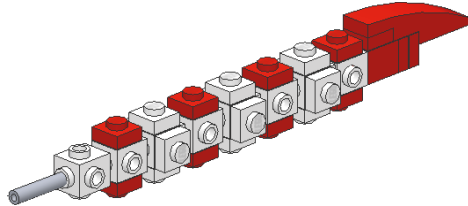

1x 2x



11



2x

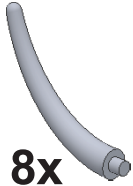

8x

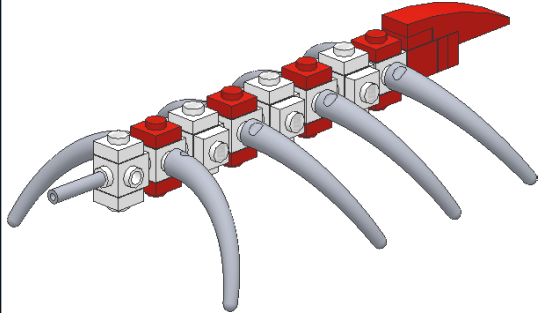

12



1x



2x

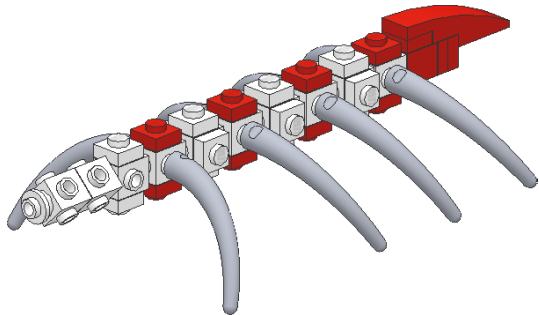

13

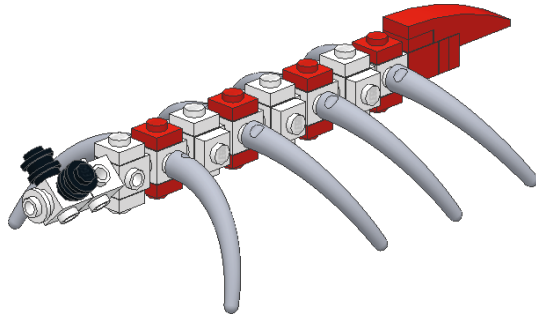
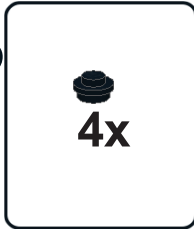

14

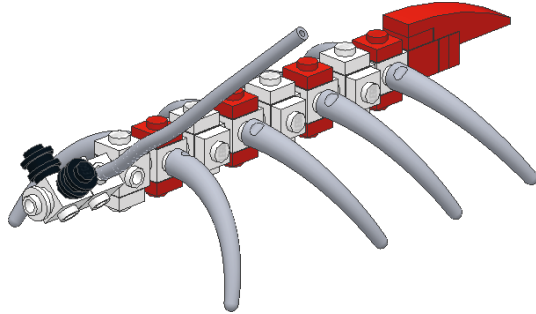

15

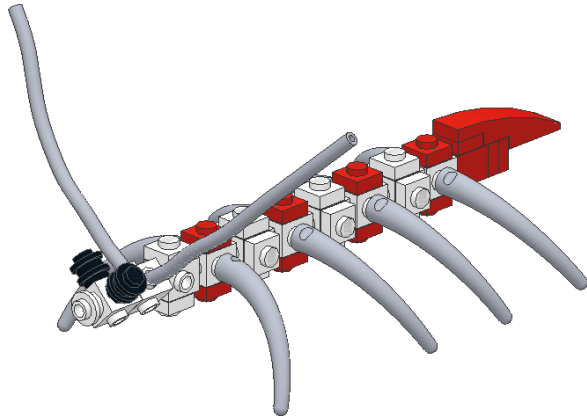

1

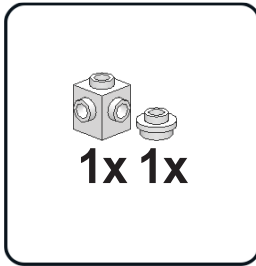

2

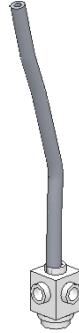

3

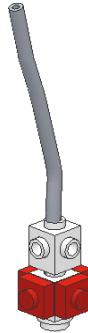
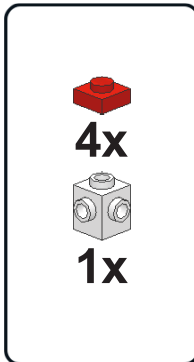

4

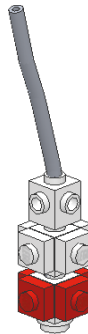
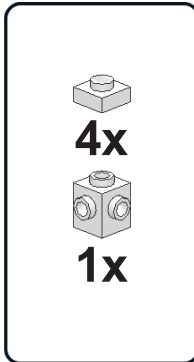

5



4x



1x

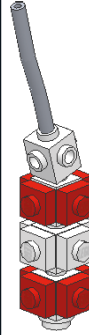

6



4x



1x



7



4x



1x



8

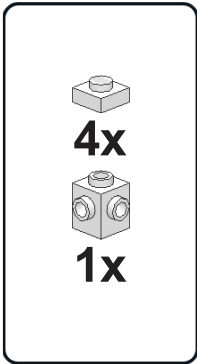

9

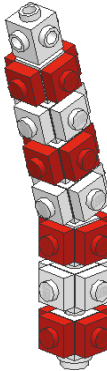
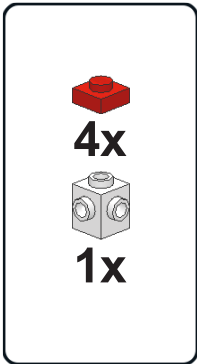

10

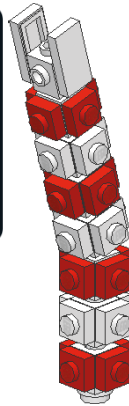
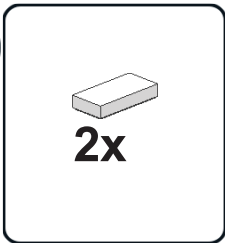

16

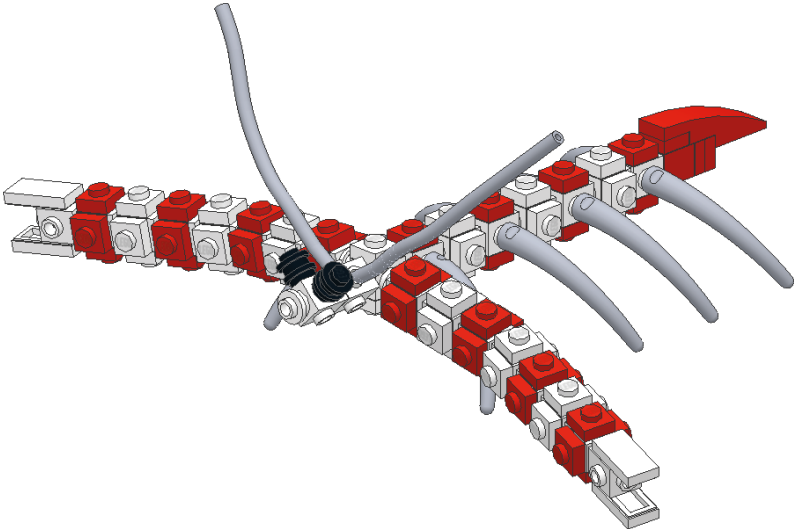

12

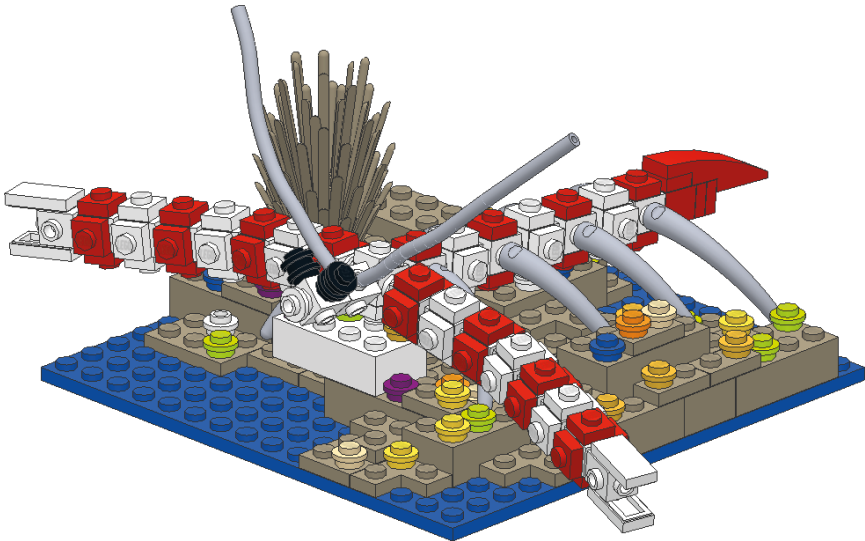

8x



6x



1x



38x



43x



7x



14x



4x



2x



1x



1x



1x



1x



8x



4x



1x



26x



1x



10x



1x



4x



3x



5x



6x



5x



5x



2x

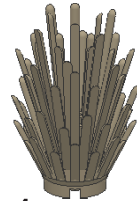
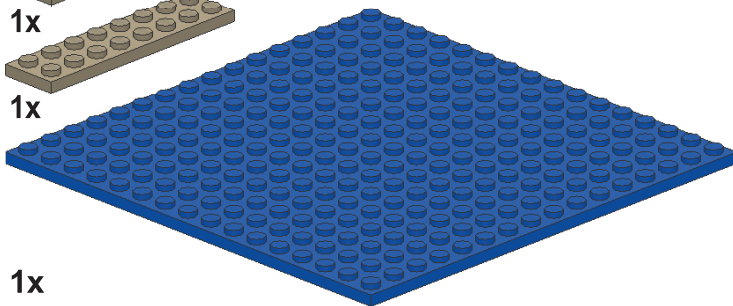

1x



4x



3x



5x



6x



5x



5x



2x

1x



1x



8x

