

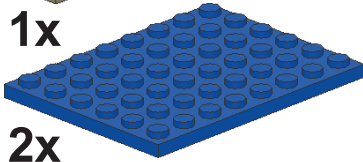

1



1x



2x

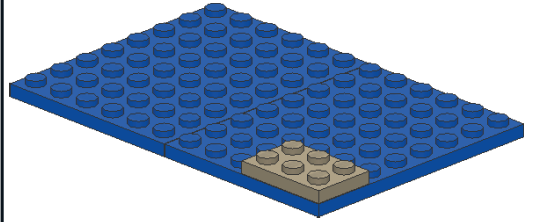

2

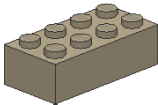

9x

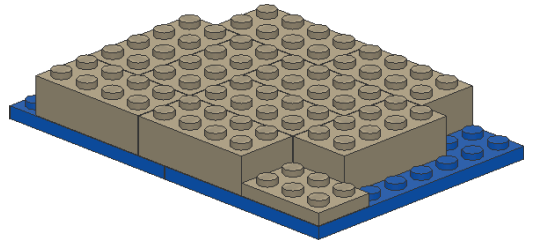

3



5x 1x 1x



5x 6x 1x

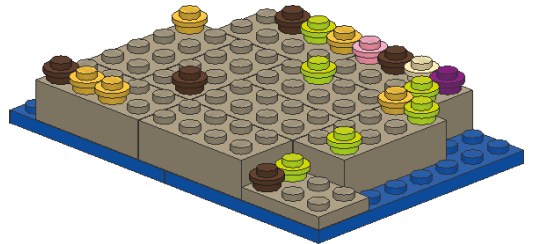

4

 2x

 1x

 2x

 2x

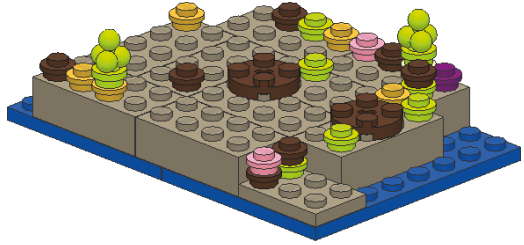

5

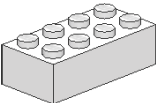
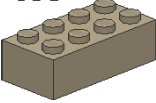
 1x

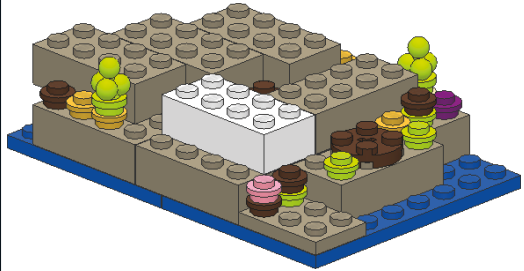
 4x



6



 3x

 3x

 3x

 3x

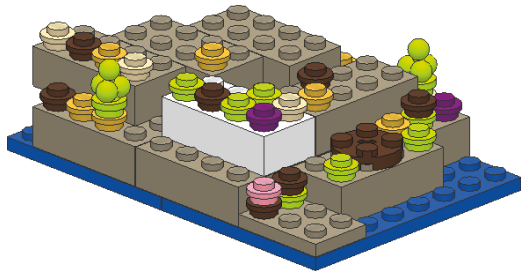
 1x



7

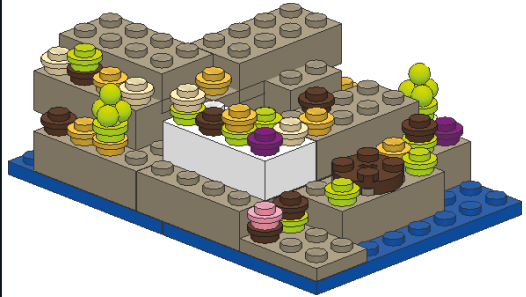
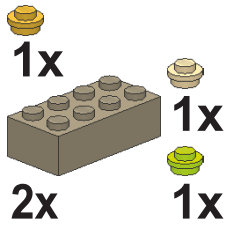

8

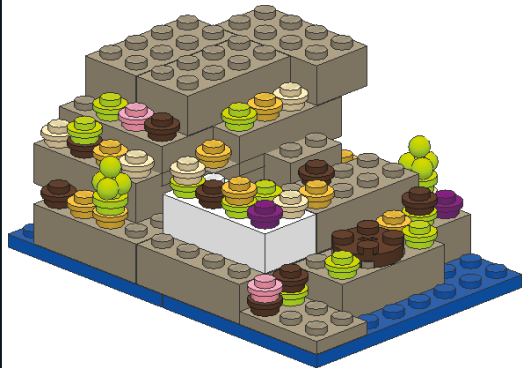
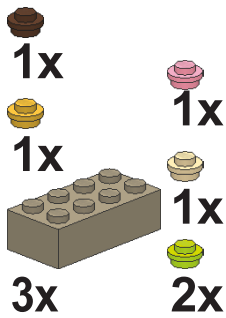

9

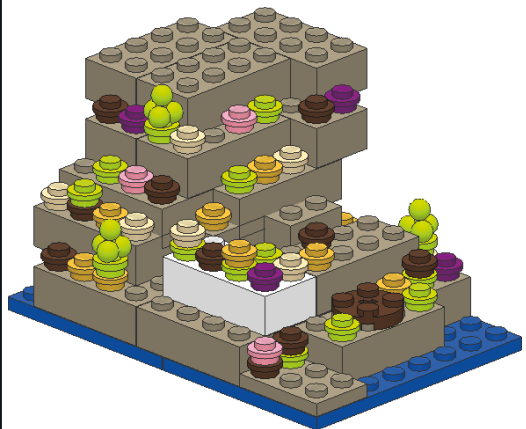
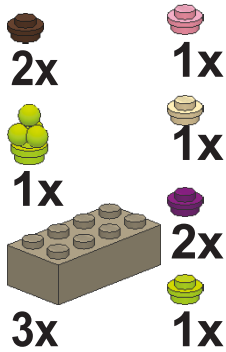

10

-  2x
-  1x
-  1x
-  1x
-  1x
-  1x

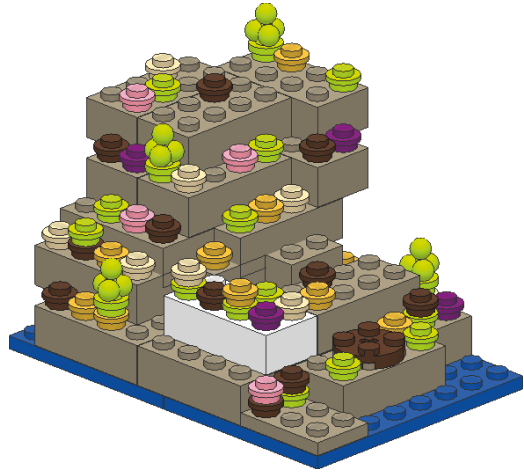

11

-  1x
-  2x
-  2x
-  1x

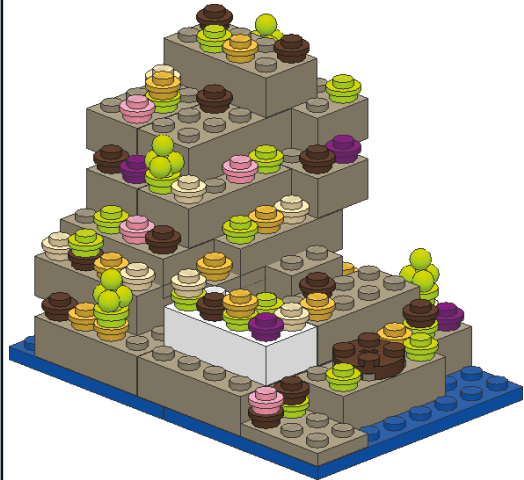

12



2x



3x



1

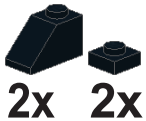

2x 2x

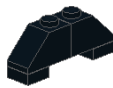

2

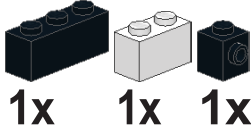

1x 1x 1x

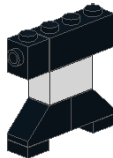

3

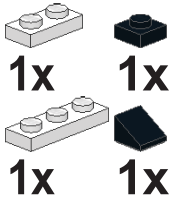

1x 1x
1x 1x

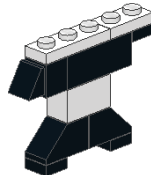

4

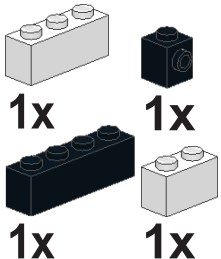

1x 1x
1x 1x

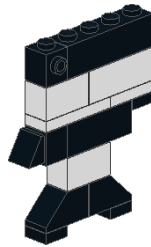

5

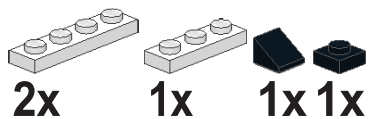

6

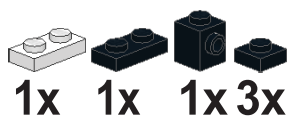

7

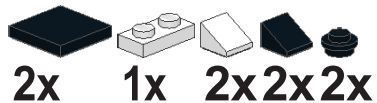

8

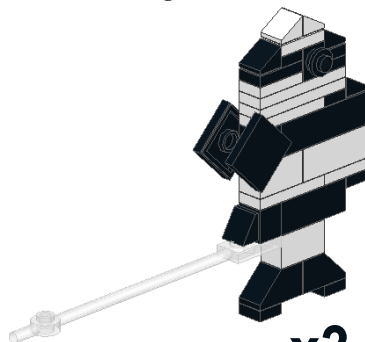
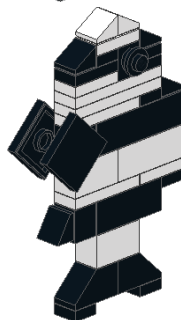
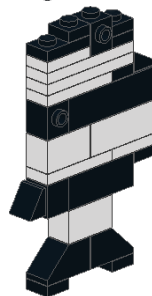
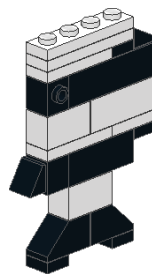

x3 7

13



