

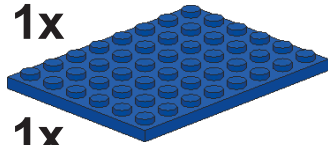

1



1x



1x

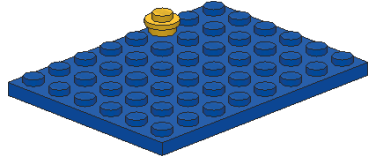

2



3x

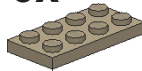

1x



1x



1x



1x



2x

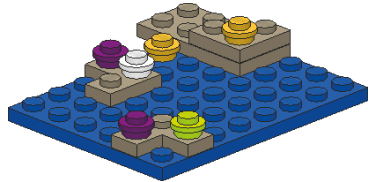

3

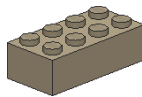

5x



1x

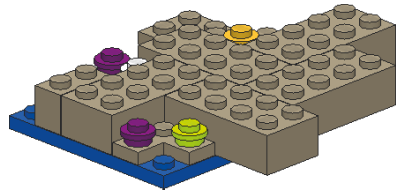

4

1x
1x
2x 2x
1x 3x

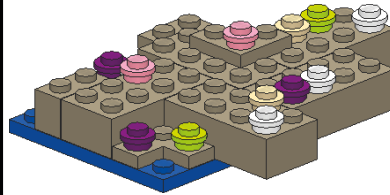

5

2x
2x
1x
1x
2x

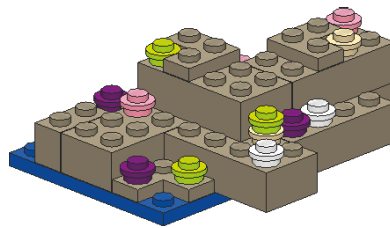

6

1x
1x 2x

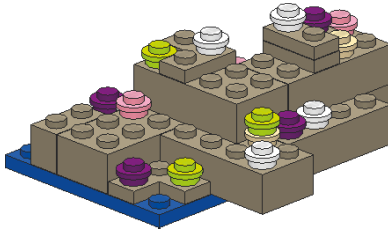

7

2x
1x
1x 2x

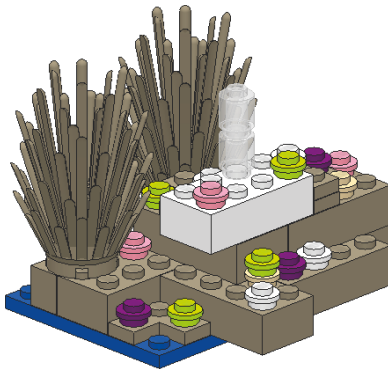

1



1x 1x

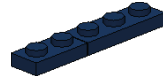

2

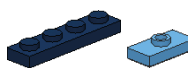

1x 2x

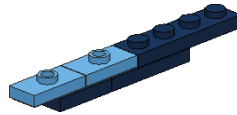

3



1x 2x 1x

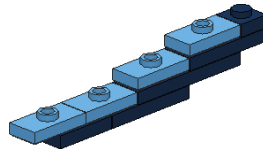

4

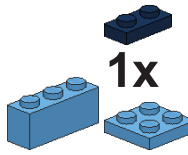

1x 1x 1x

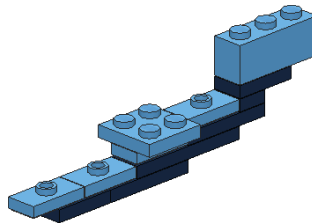

5

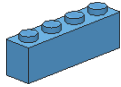

1x

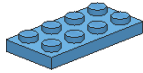

1x

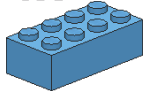

1x

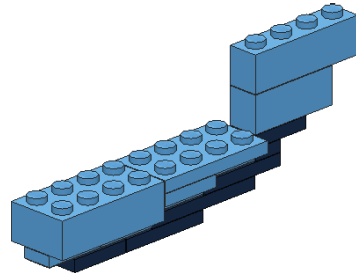

6



2x

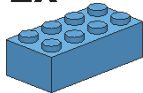

2x



1x



1x

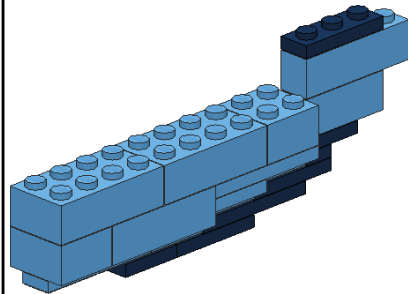

7



1x



1x



1x



2x



1x



1x



1x



1x

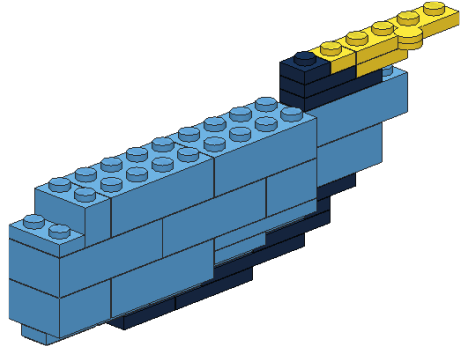

8



1x



1x



1x







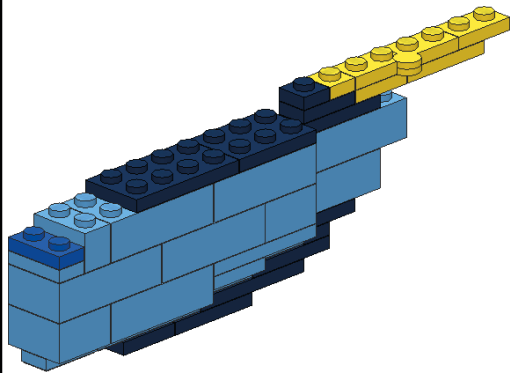

1x



1x







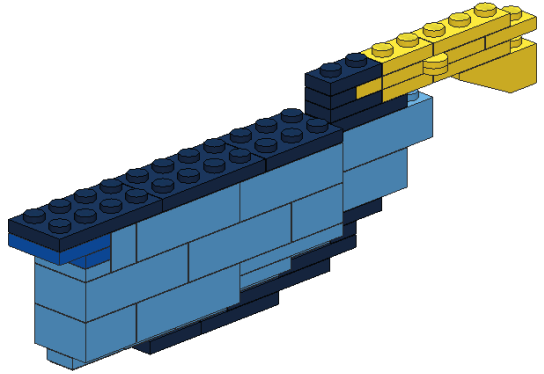

9

- | | |
|---|---|
| 
1x | 
1x |
| 
1x | 
1x |
| 
1x | 
1x |



10

- | | |
|---|---|
| 
2x | |
| 
1x | |
| 
1x | |
| 
2x | |
| 
1x | |
| 
1x | 
2x |

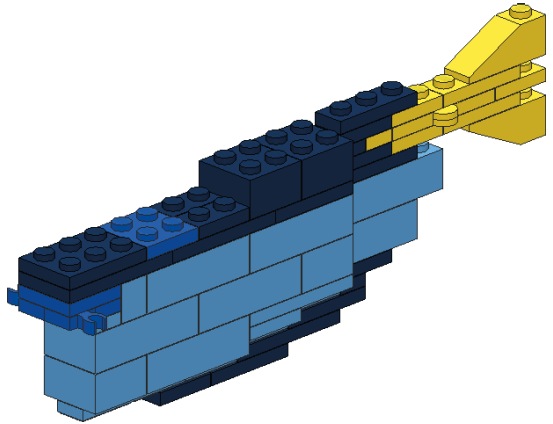



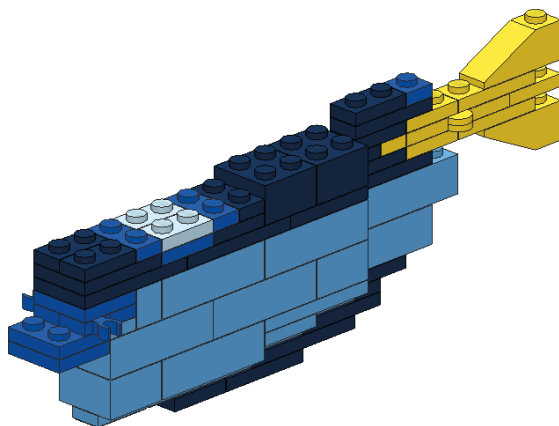
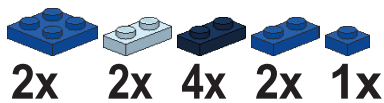

11

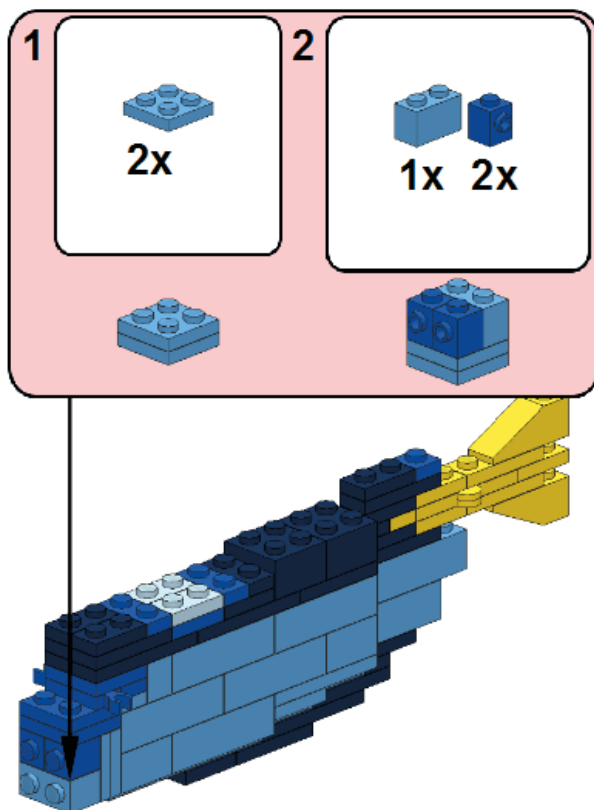

12







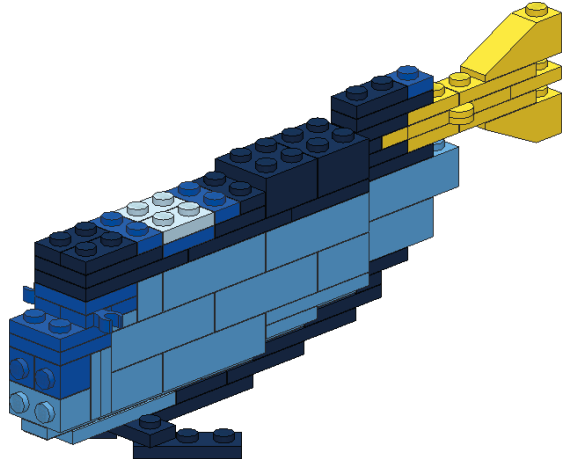



13

-  1x
-  3x
-  1x
-  1x



14

-  2x
-  1x
-  2x
-  2x
-  1x
-  1x
-  1x
-  2x

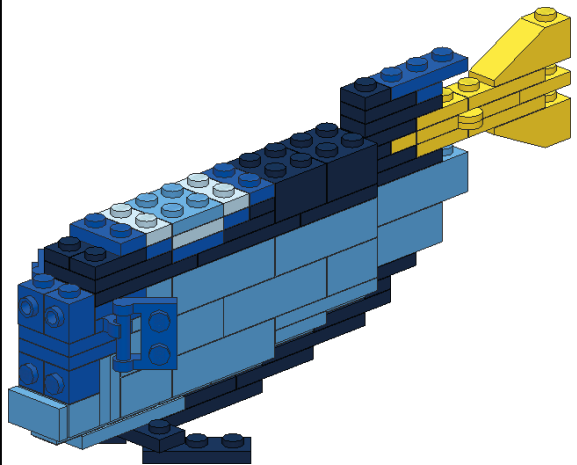

15



2x



1x



1x



1x



5x



2x

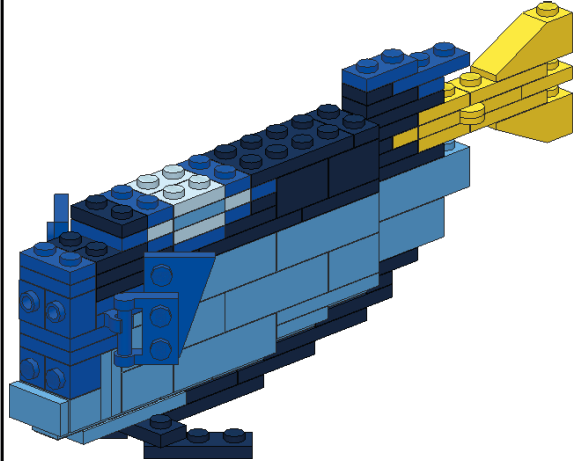

16



1x



1x

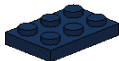

2x

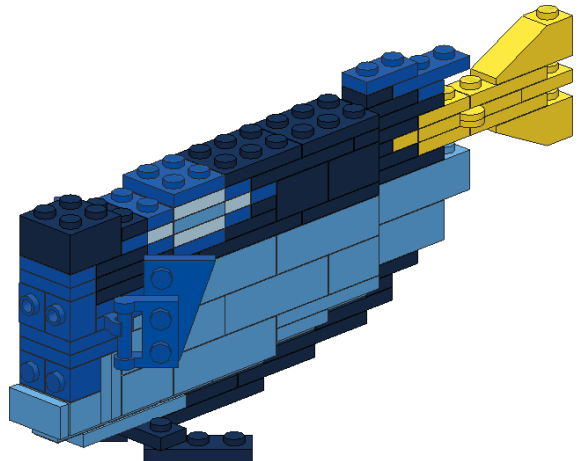

17



2x



1x



1x



2x

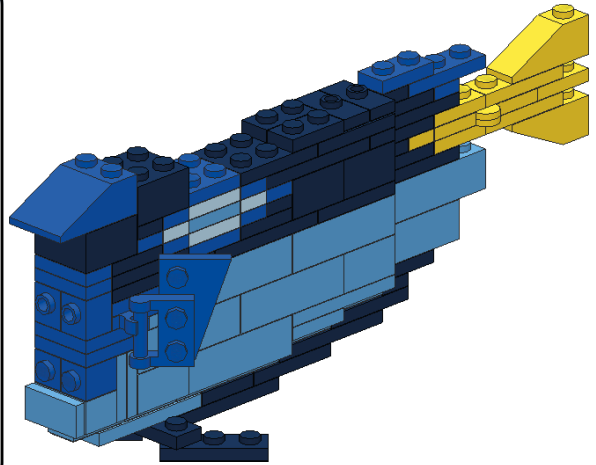

18



2x



1x

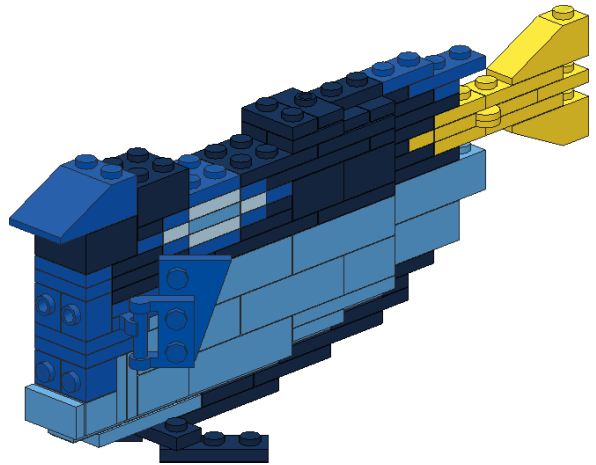

19



2x



2x



1x



2x

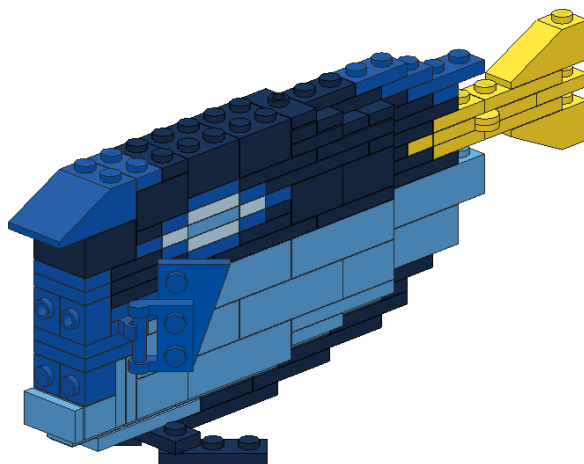

20



6x

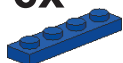

1x

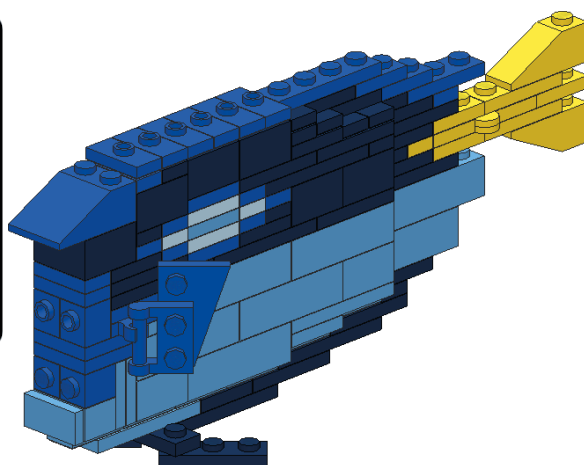

21

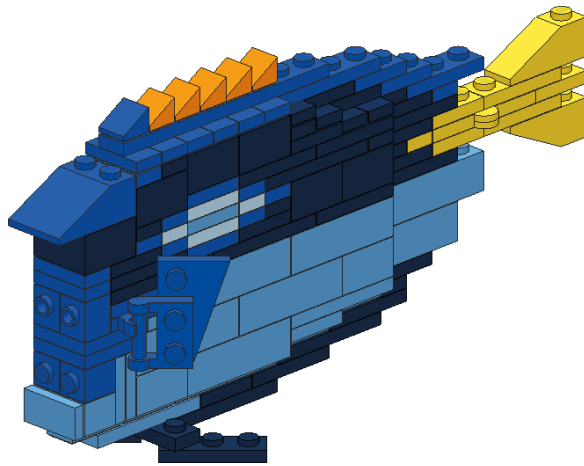
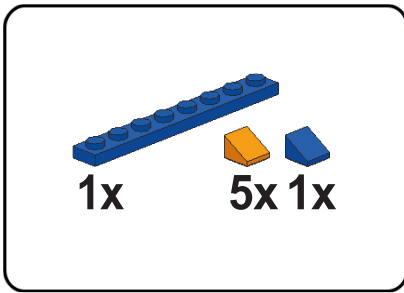

1

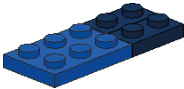
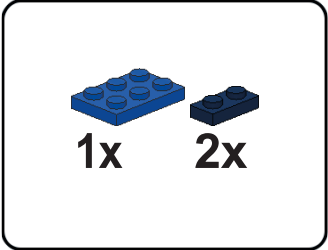

2

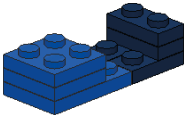
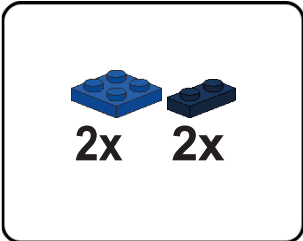

3

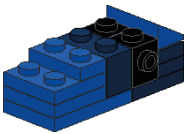
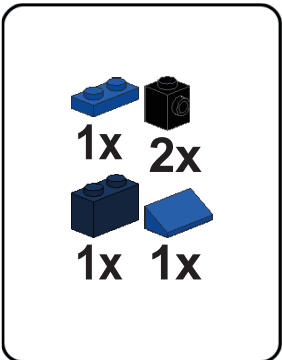

4

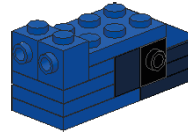
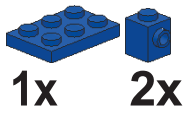

5

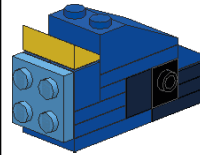
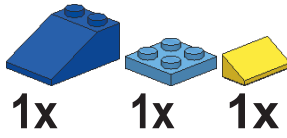

6

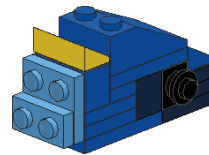
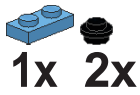

22

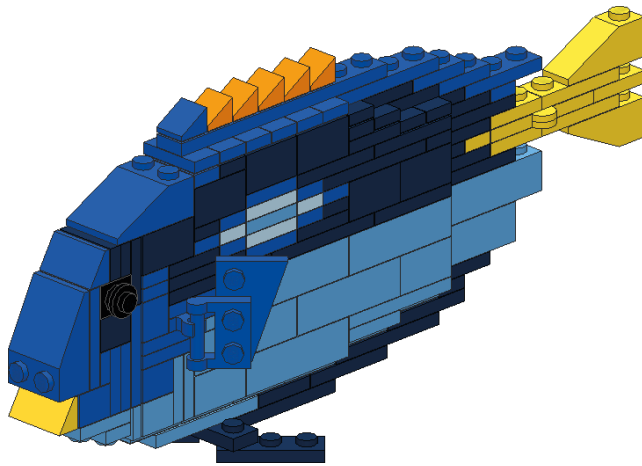

8



