

1

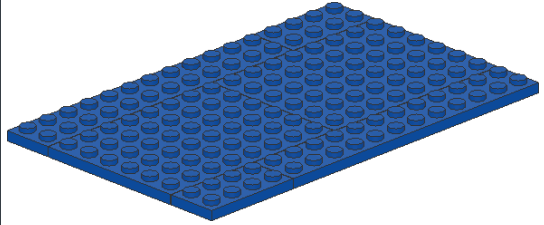

2

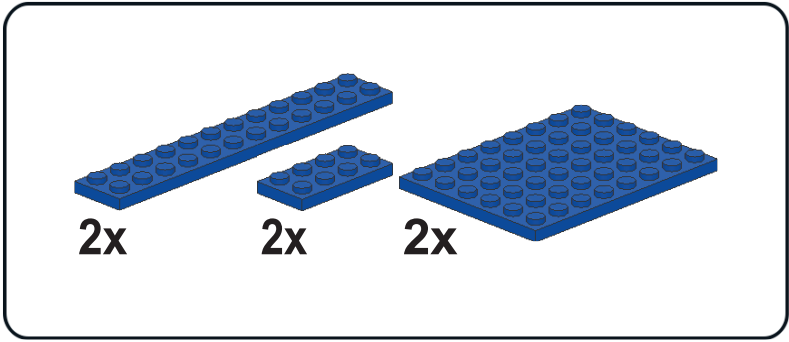
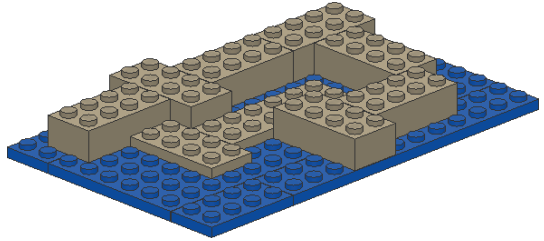
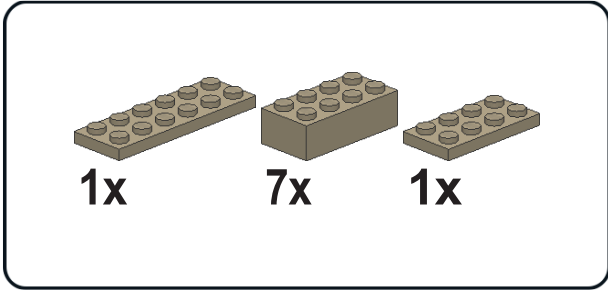

3

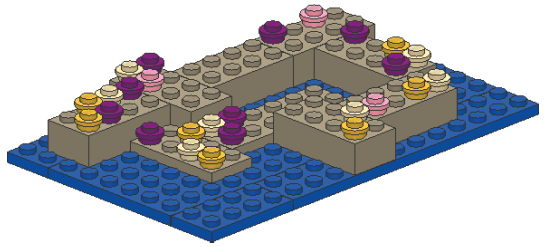
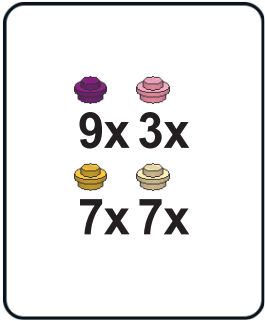

4

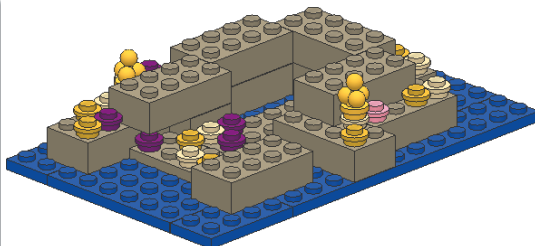
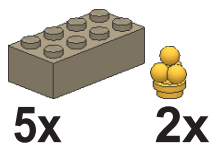

5

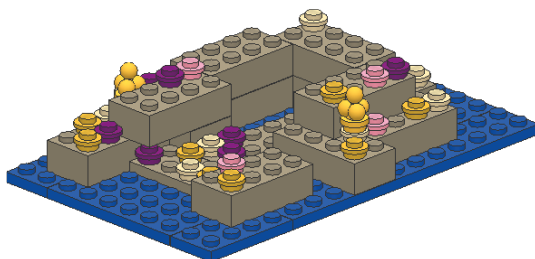

6

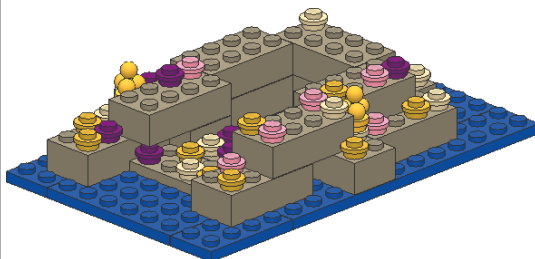
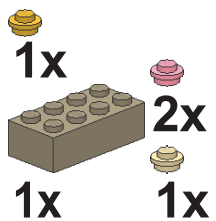

7



1x

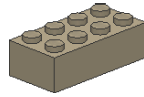

6x

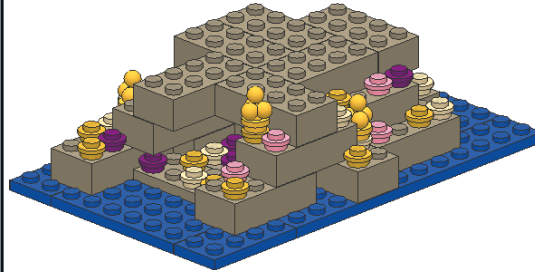

8



5x



7x



4x 4x

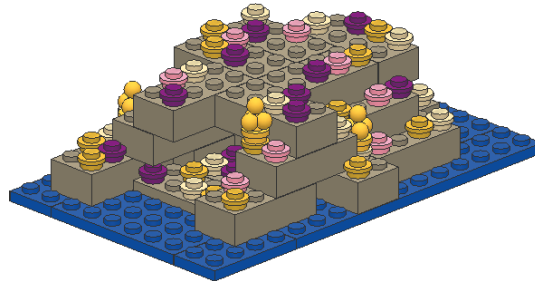

9

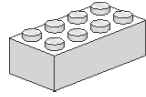

1x



4x



1x



2x

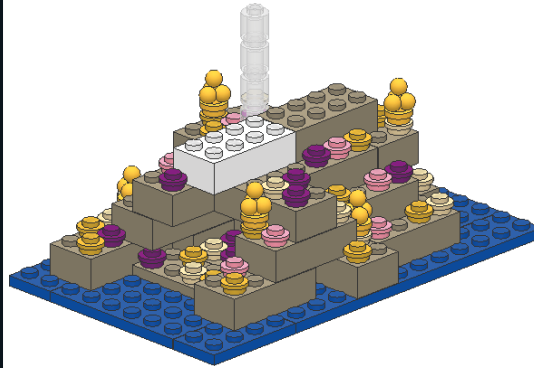

10



2x



2x



4x



2x

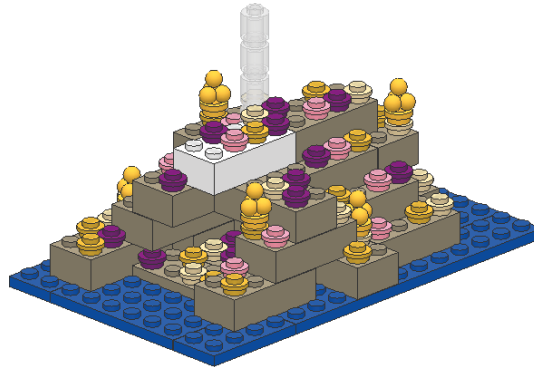

1

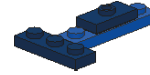
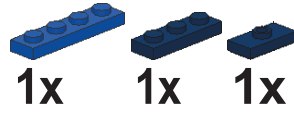

2

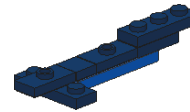
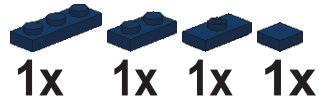

3

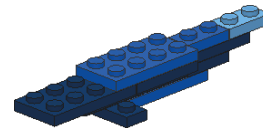
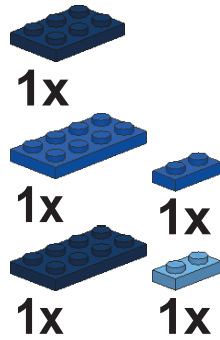

4

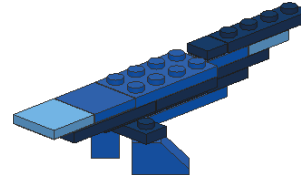
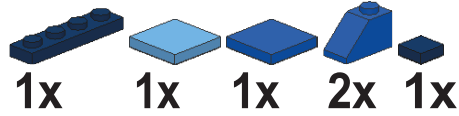

5

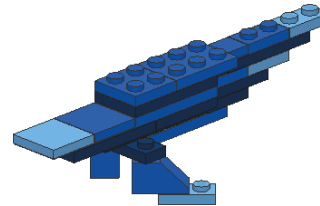
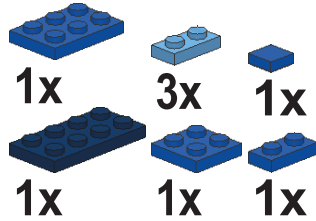

6

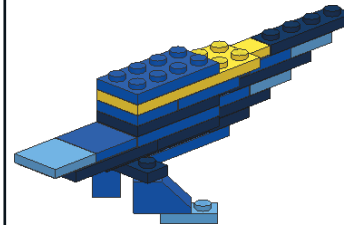
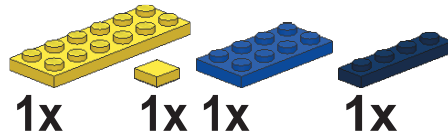



7

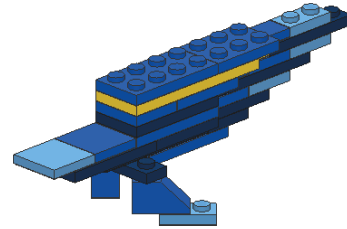
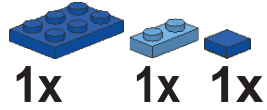

8

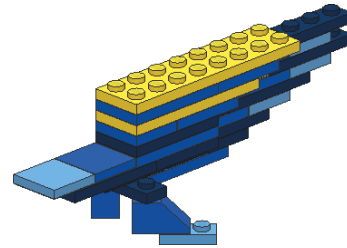
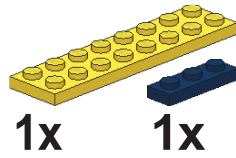

9

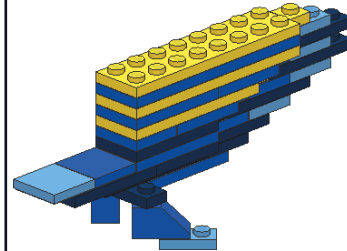
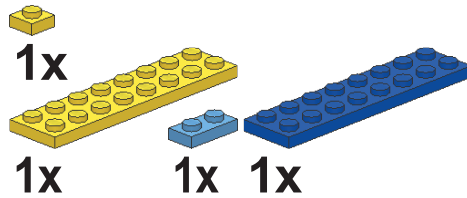

10

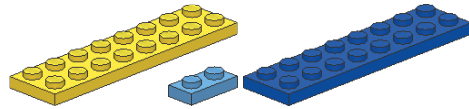

1x 1x 2x

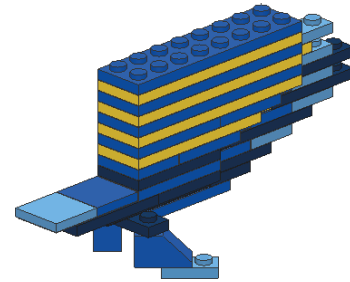

11

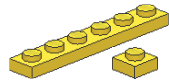

1x 1x

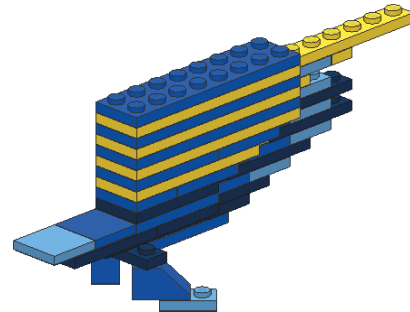

12



1x 1x 1x 1x

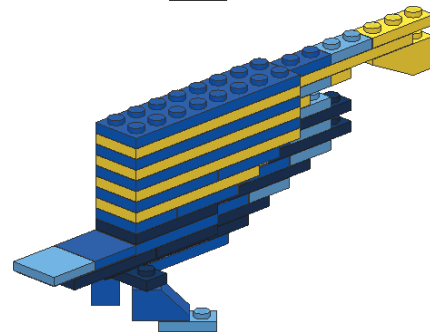

13

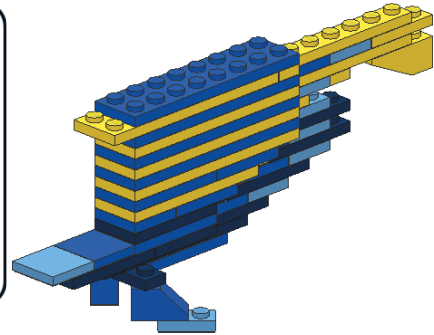
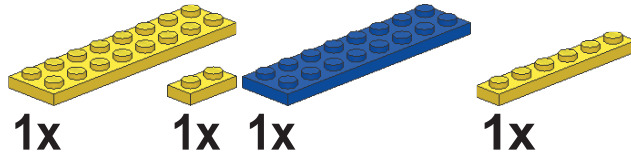

14

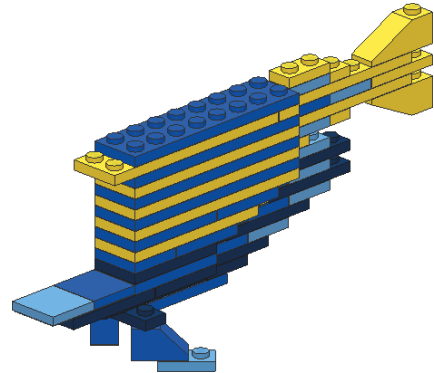
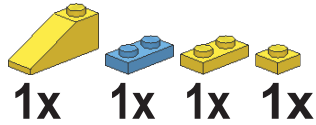

15

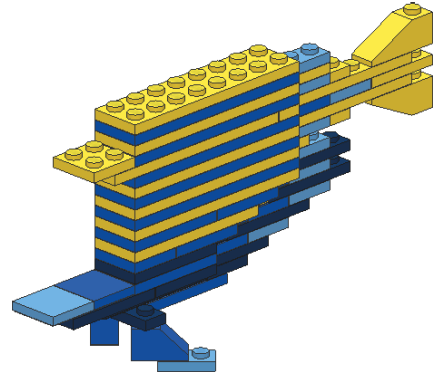
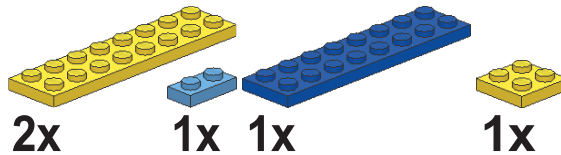

16

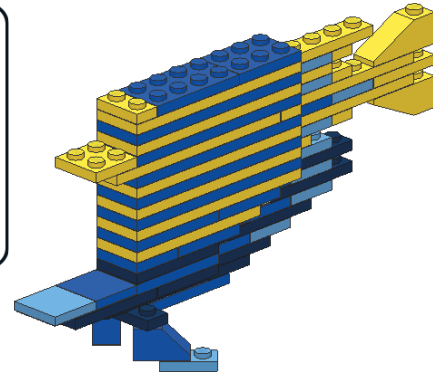
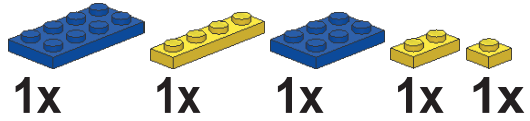

17

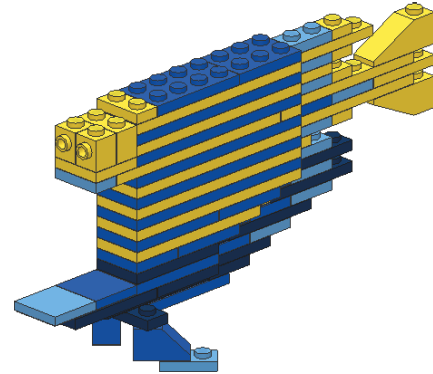
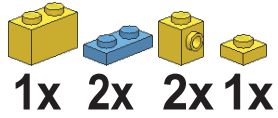

18

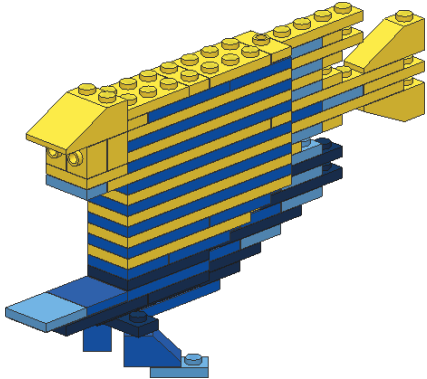
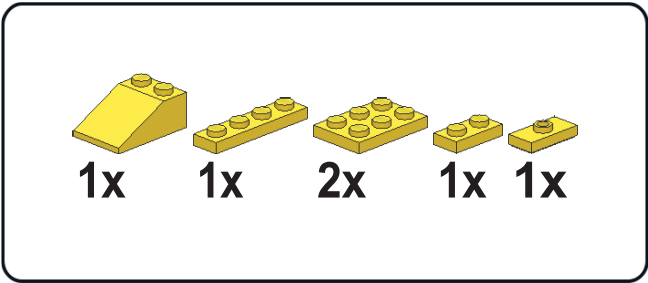

19

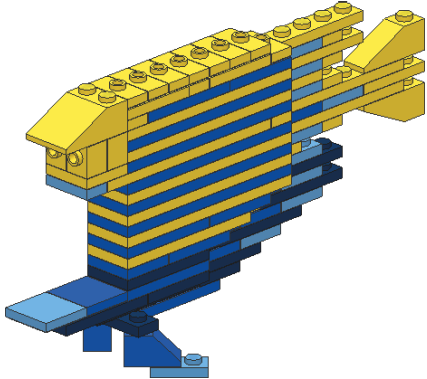
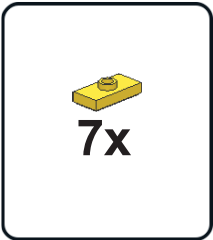

**20**

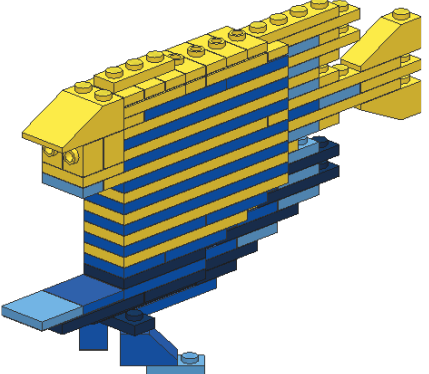
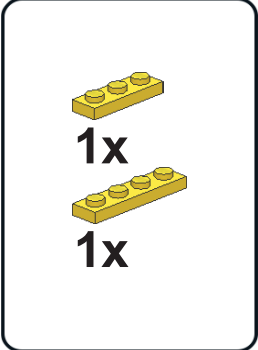

**21**

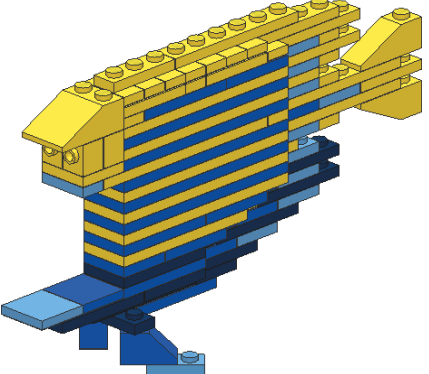
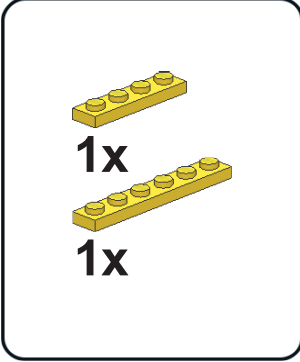

**22**

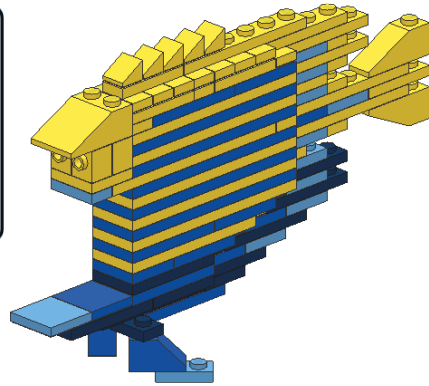
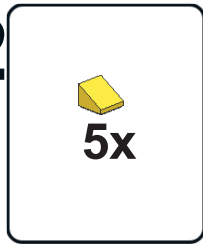

1

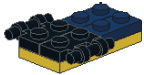
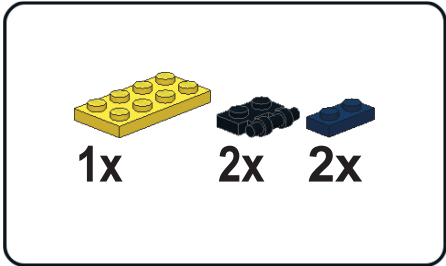

2

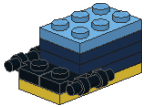
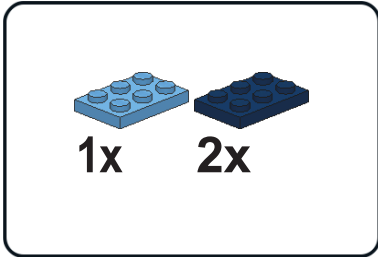

3

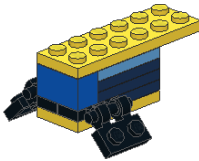
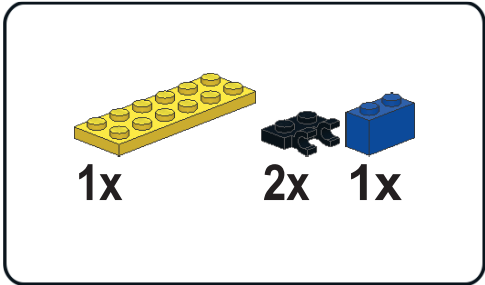



4

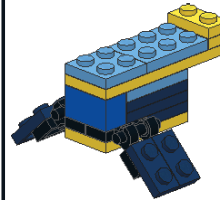
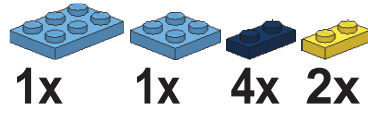

5

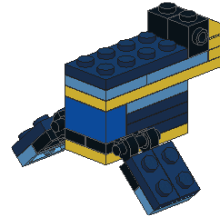
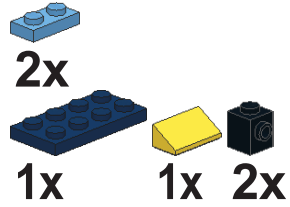

6

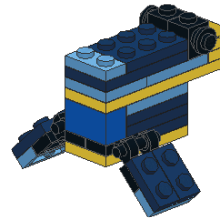
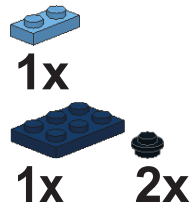

7

1x 2x  
1x 2x

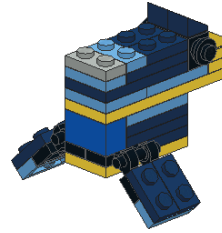

8

1x  
2x 1x

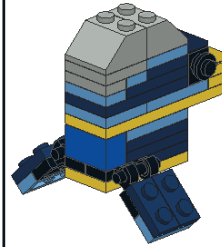

9

2x

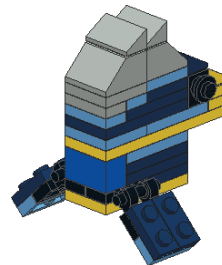

23

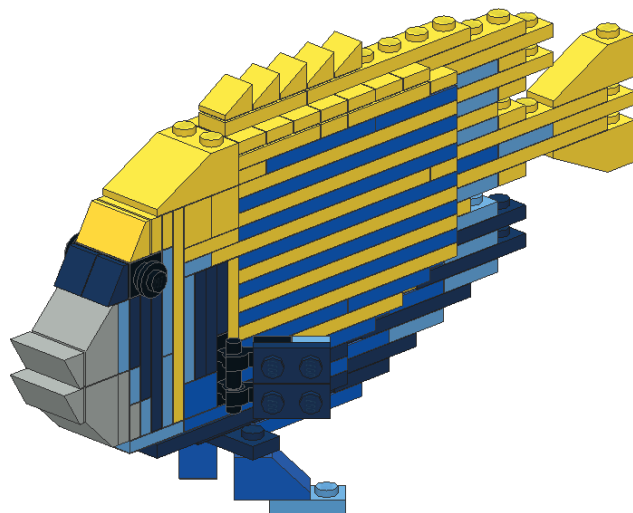

11

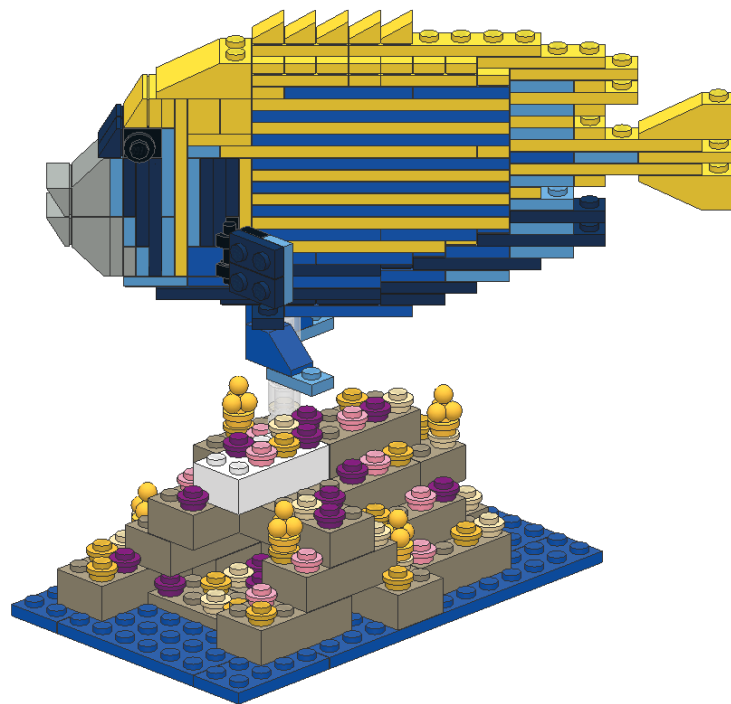

18

